

Article number: 201463B32562SW

Description: E+G
Flanged Connector GN 146.3-B32-56-2-SW

Measures

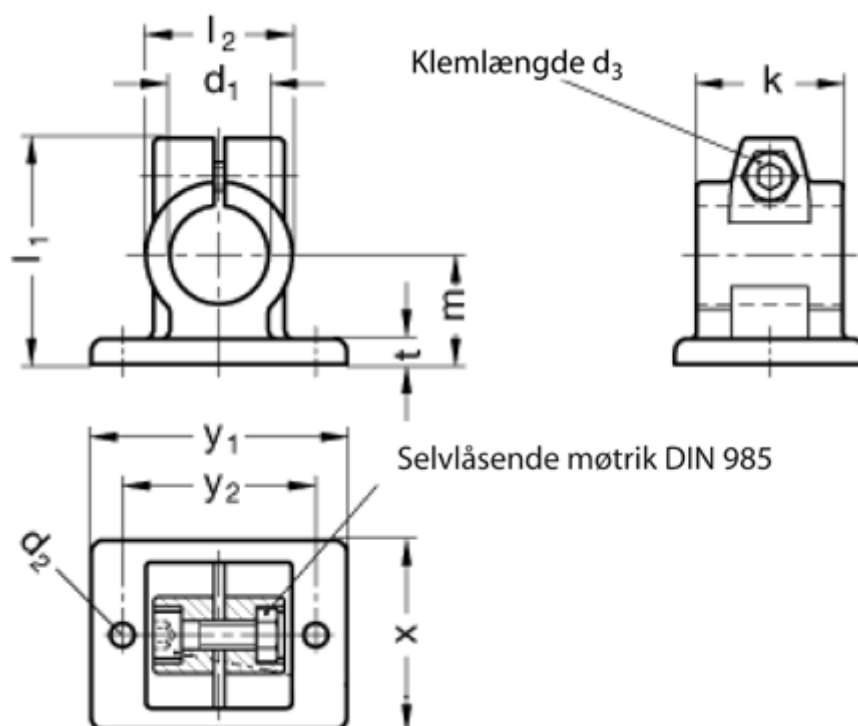

Adjustable clamp lever = GN 911-M10-40 have to be ordred separately

d_1 = B32
 d_2 = 8.5
 d_3 = M10
 k = 56
 l_1 = 83
 l_2 = 56
 m = 42

t = 10
 x = 78
 y_1 = 108
 y_2 = 82